

Salles de la Maison de la communication

Lexique.....	1
Plan 1 ^{er} et 2 ^{ème} étages.....	2
Plan 3 ^{ème} étage.....	3

1er étage

Salle 1B.....	4
Salle 1C (Auditoire).....	5
Salle 1D.....	6

2^{ème} étage

Salle 2A.....	7
Salle 2B.....	8
Salle 2C.....	9
Salle 2D.....	10
Salle 2E.....	11
Salle 2F.....	12
Salle 2G.....	13

3^{ème} étage

Salle 3A.....	14
Salle 3B.....	15
Salle 3C.....	16
Salle 3D.....	17

Entresol

Salle des Conseils.....	18
-------------------------	----

Plan des étages

1^{er} étage

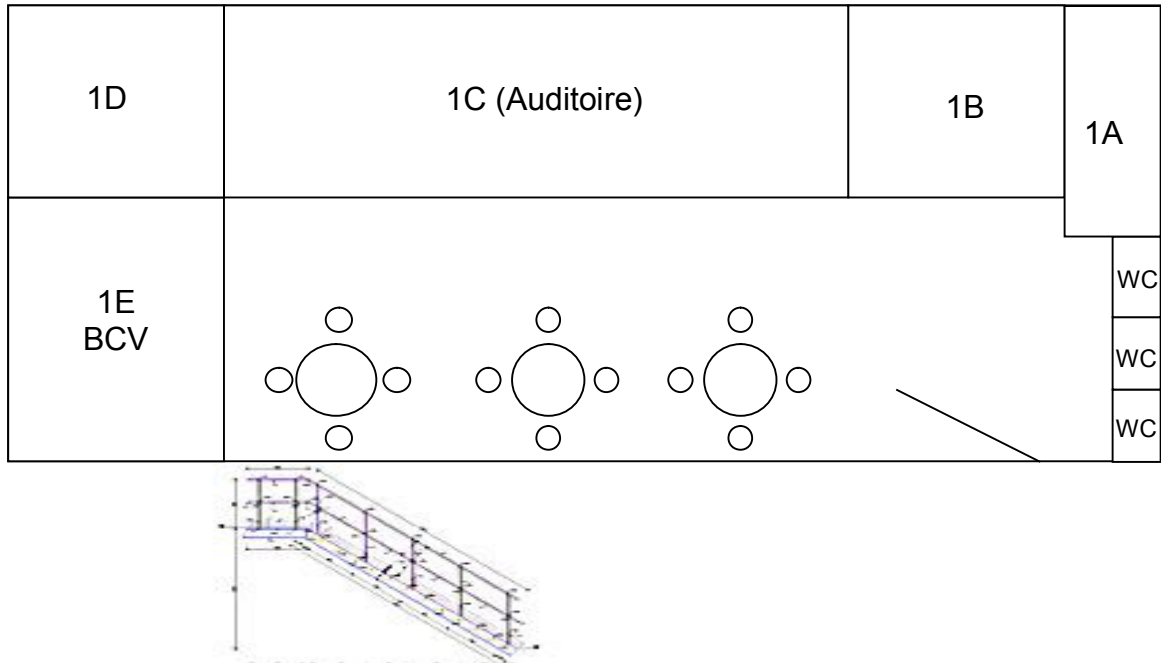

2^{ème} étage

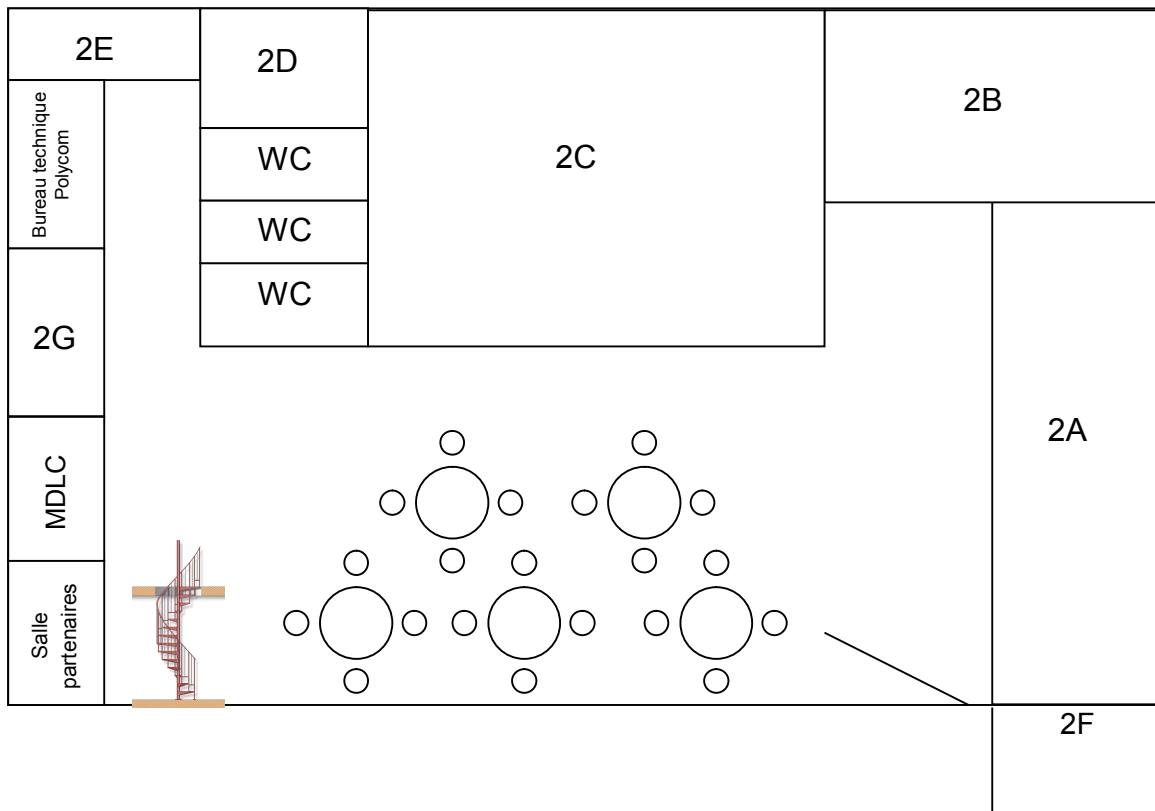

3^{Eme} étage

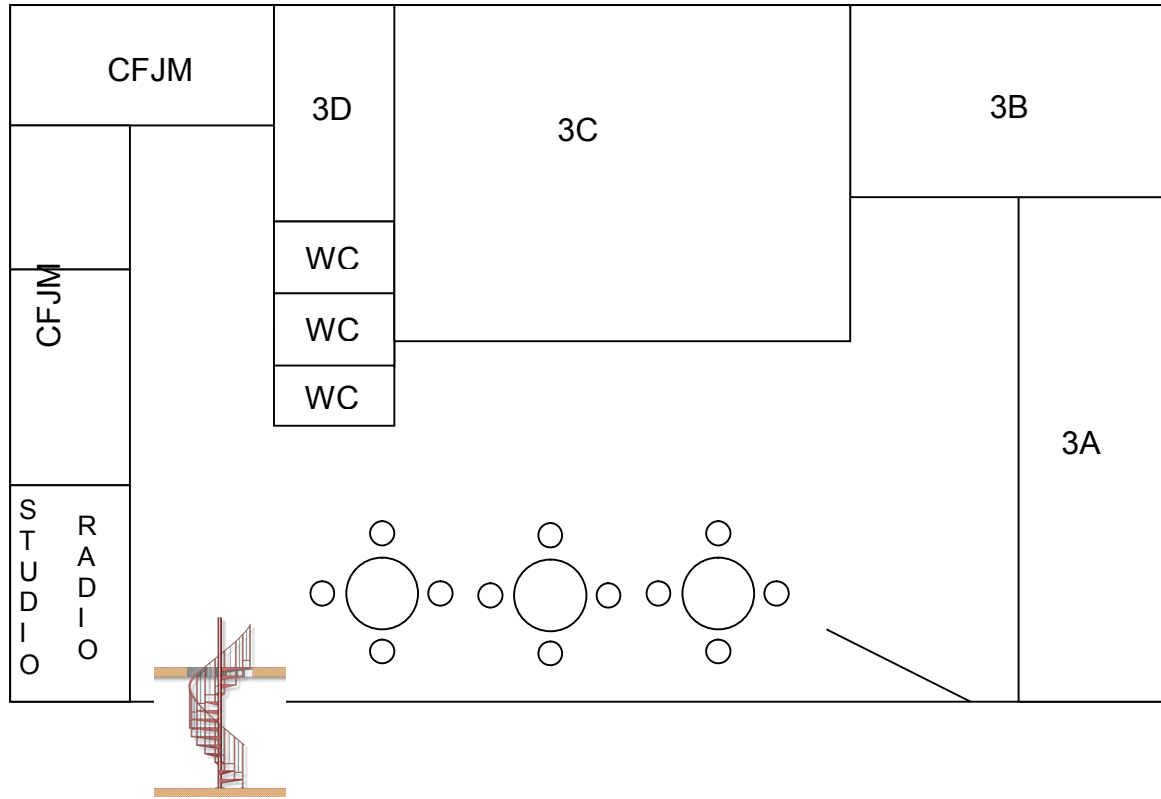

Salle 1B

1^{er} étage

14 tables

28 places

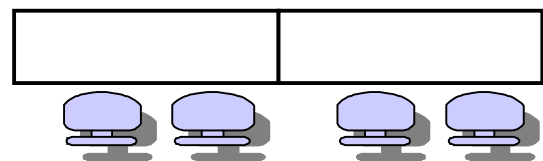
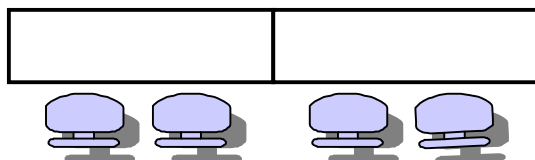
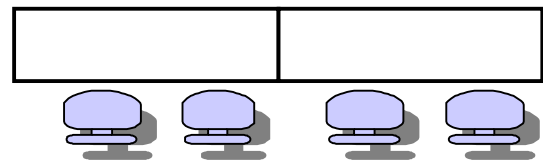
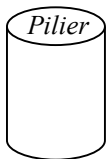
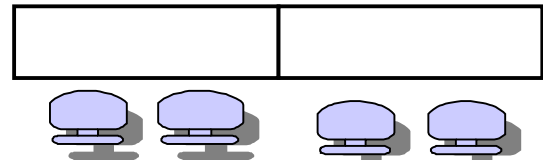
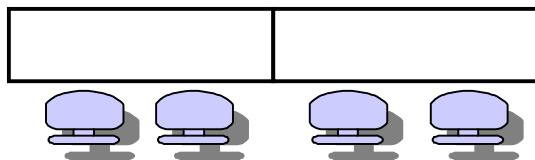
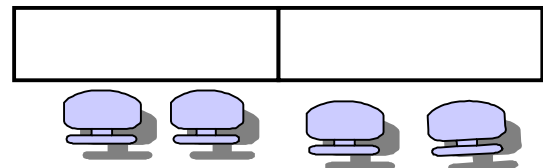
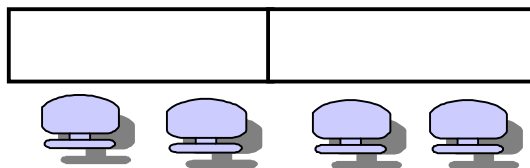
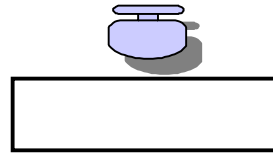

Salle 1C

1^{er} étage

160 places

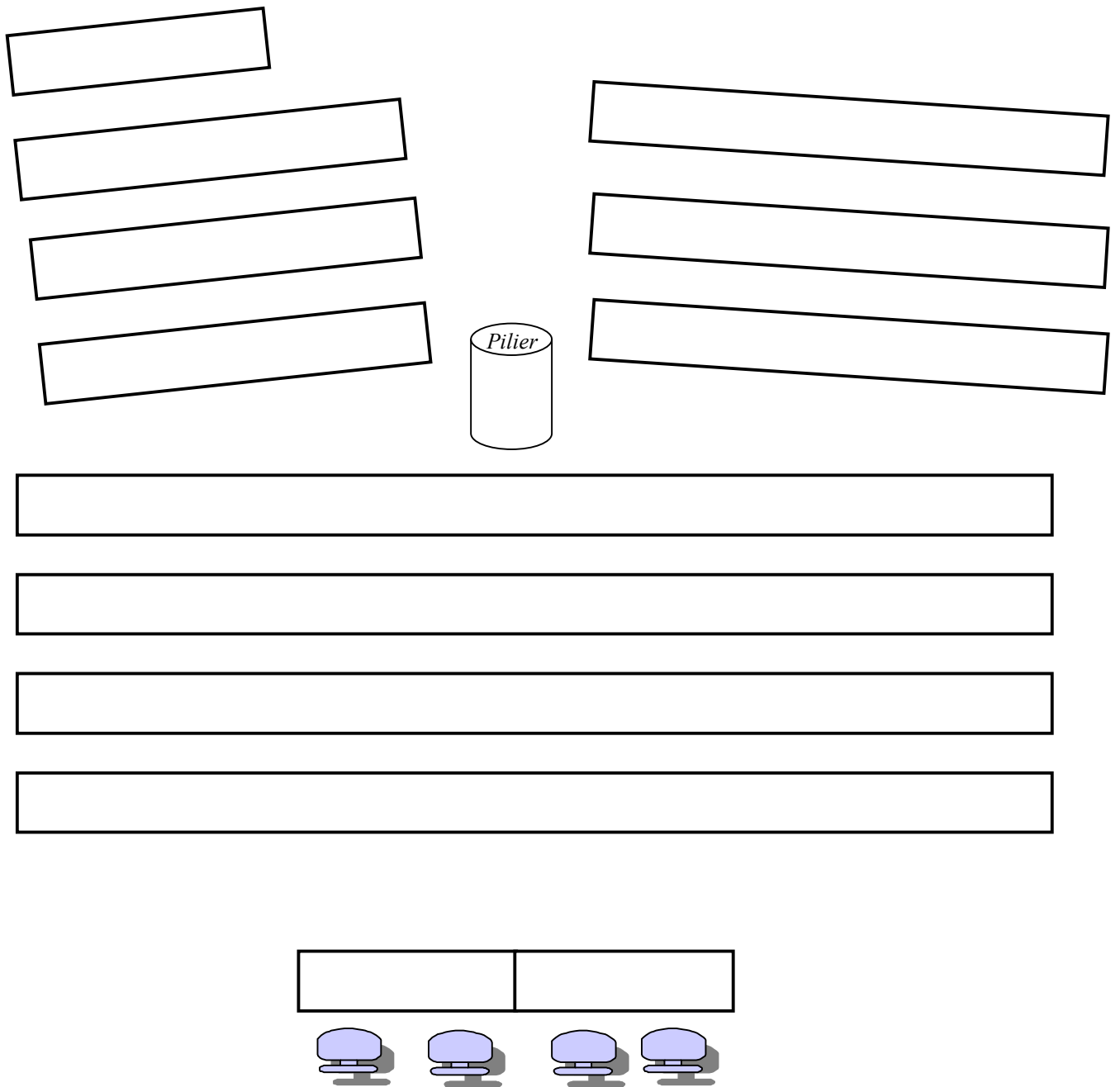

Salle 1D

1er étage

21 tables - 42 places

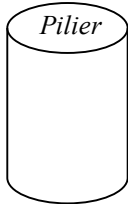
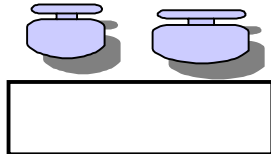
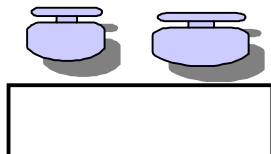
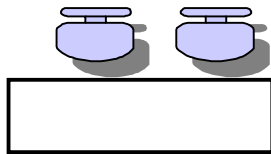
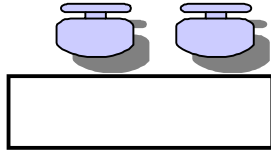
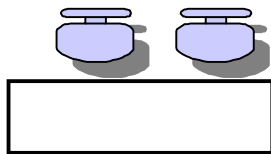
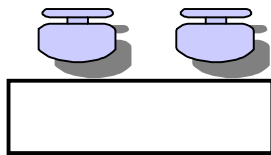
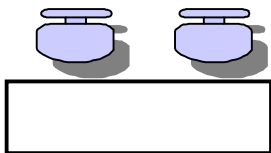
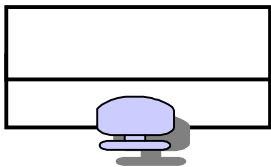
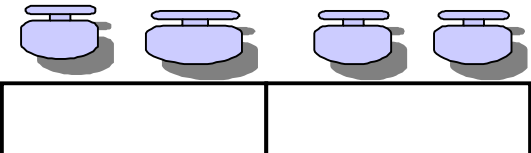
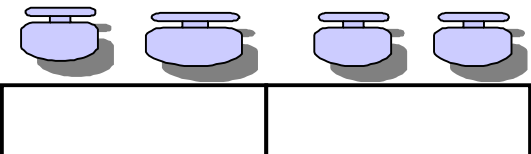
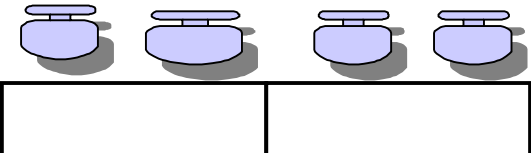
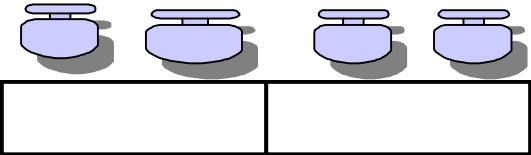
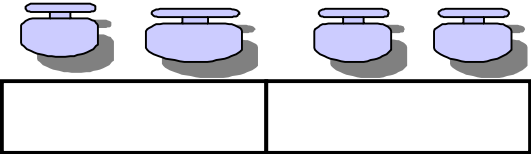
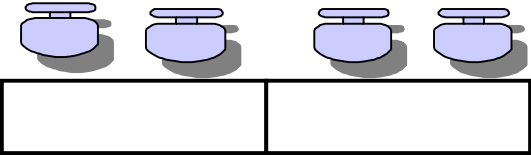
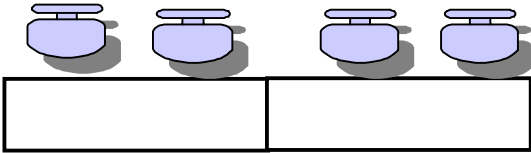

Salle 2A

2^{ème} étage

20 tables

40 places

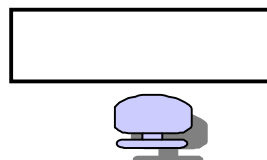
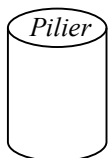
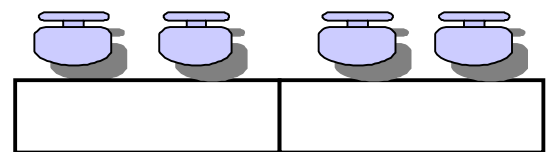
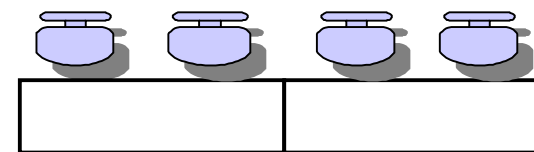
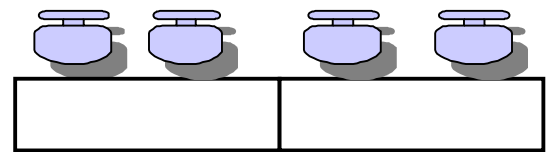
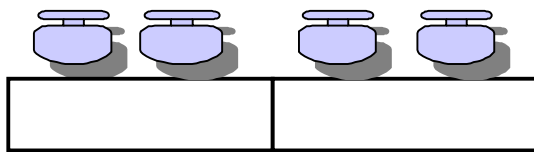
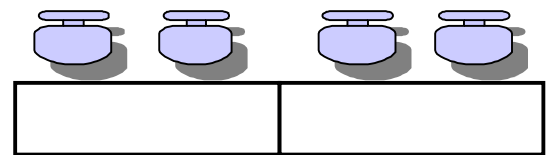
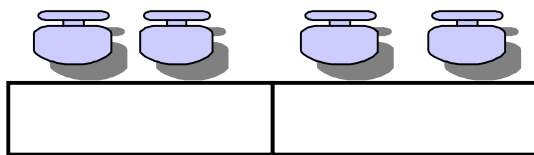
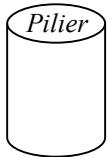
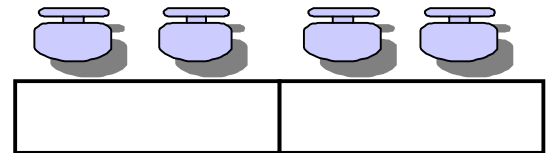
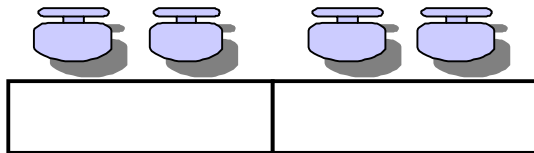
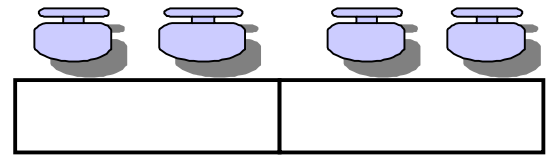
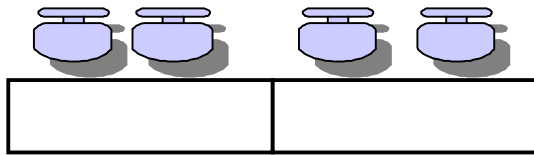

Salle 2B

2^{ème} étage

12 tables

24 places

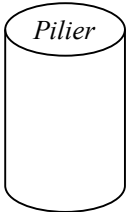
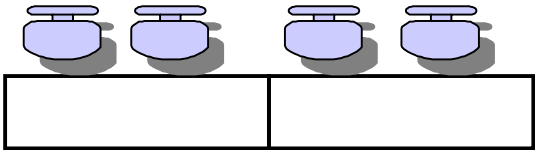
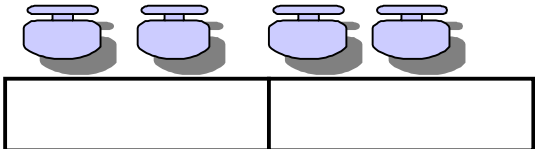
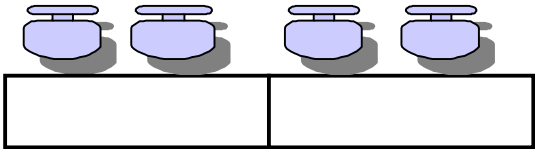
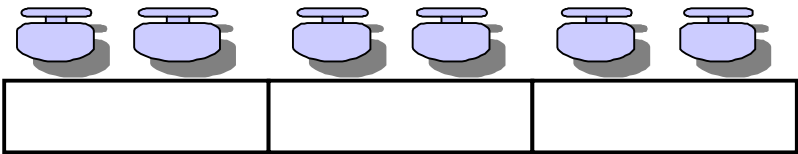
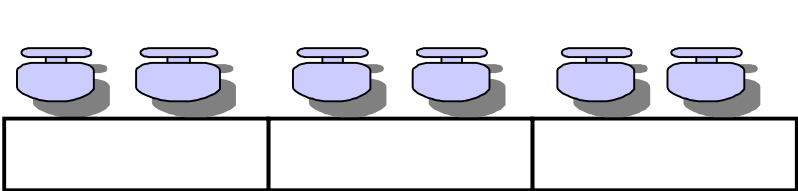

Salle 2C

2^{ème} étage

20 tables

40 places

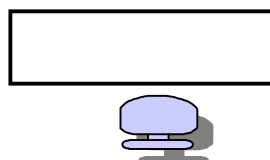
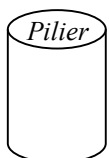
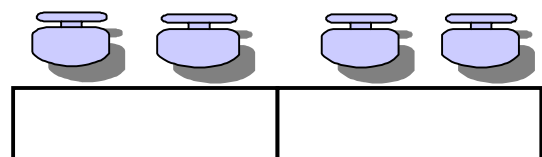
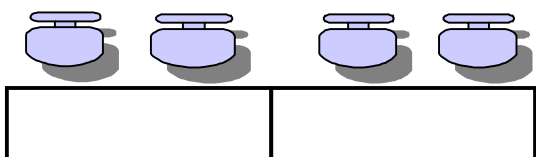
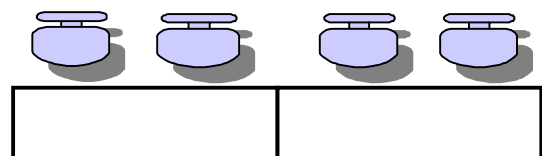
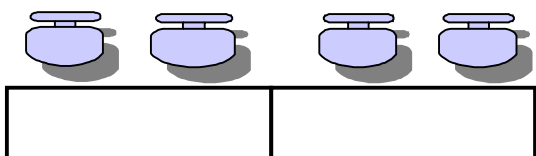
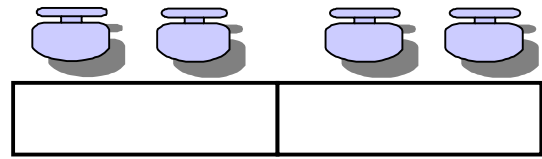
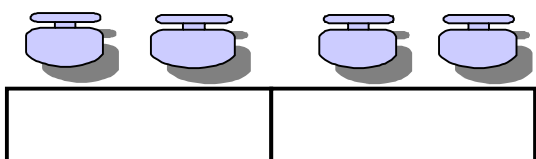
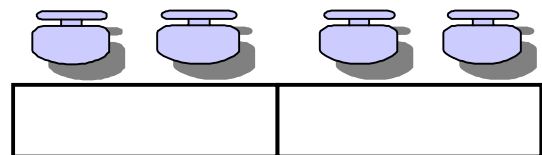
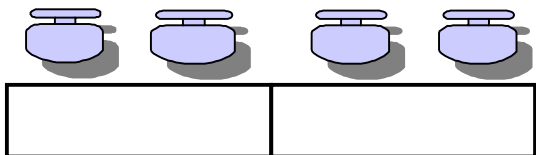
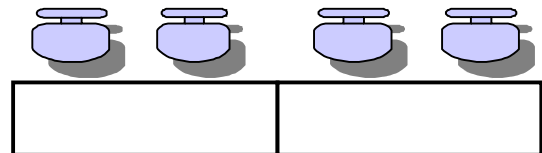
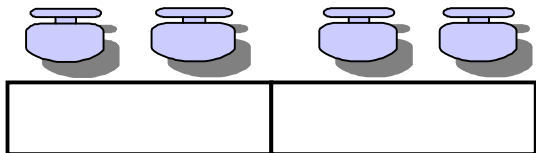

Salle 2E

2^{ème} étage

6 tables

12 places

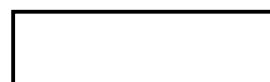
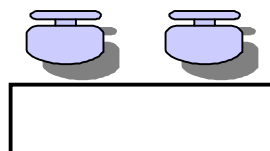
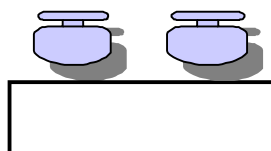
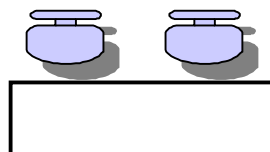
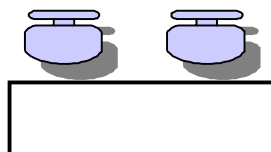
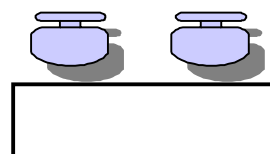
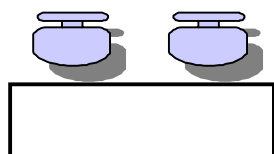

Salle 2D

2^{ème} étage

3 tables

10 places

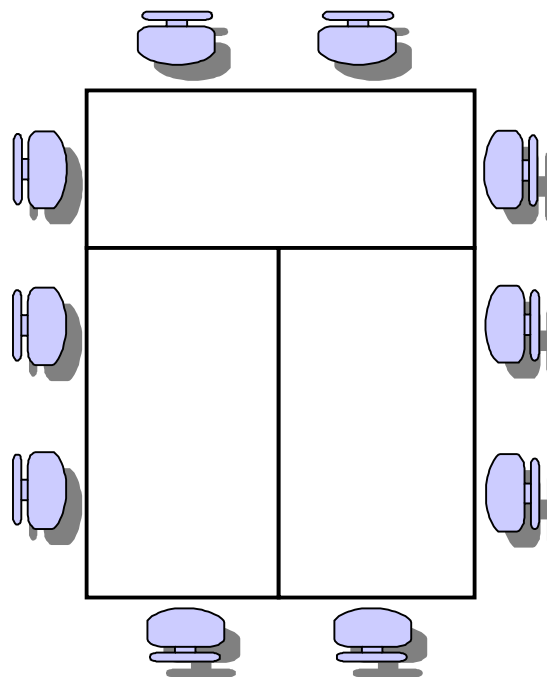
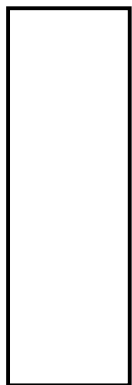

Salle 2F

2^{ème} étage

6 tables

12 places

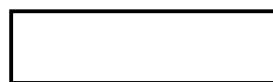
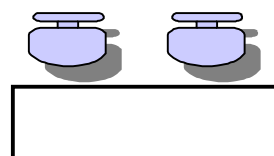
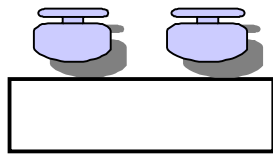
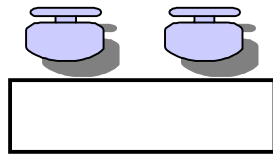
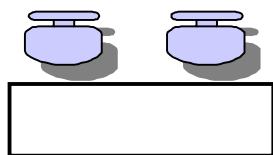
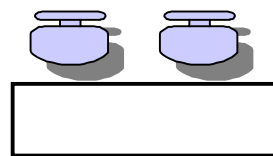
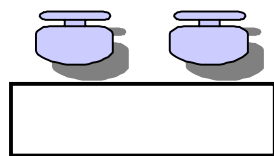

Salle 2G

2^{ème} étage

2 tables

10 places

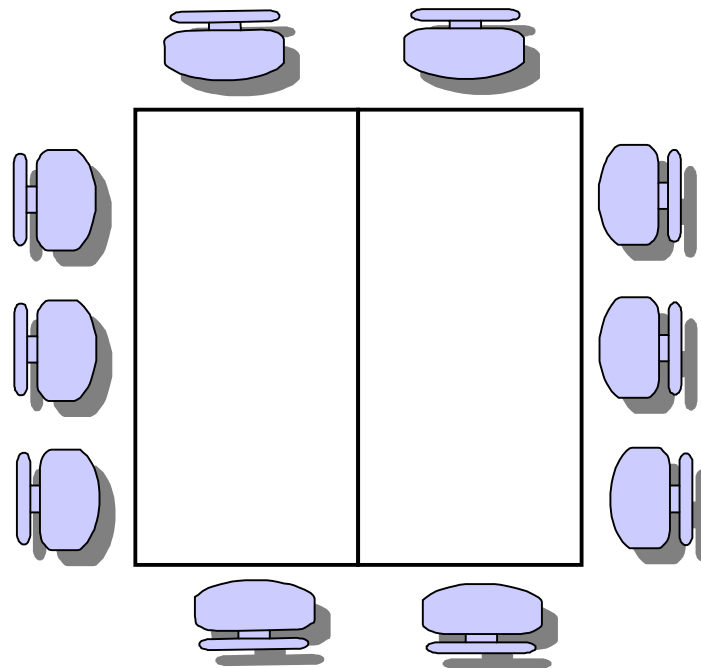

Salle 3A

3ème étage

18 tables

36 places

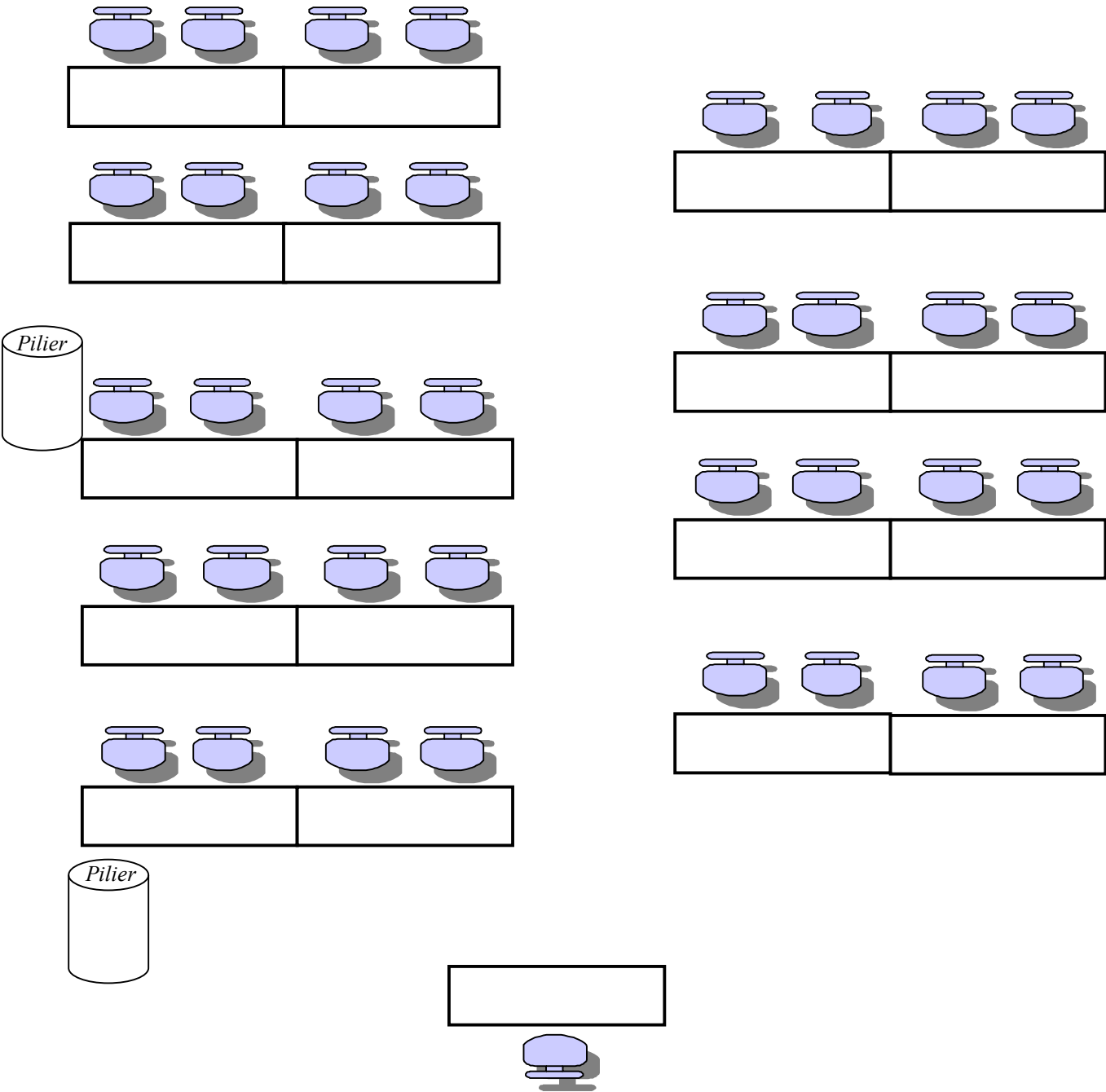

Salle 3B

3^{ème} étage

16 tables

32 places

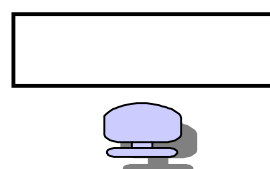
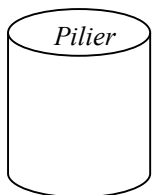
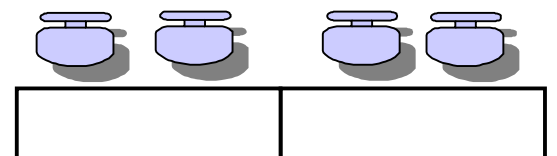
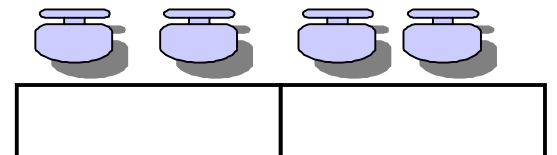
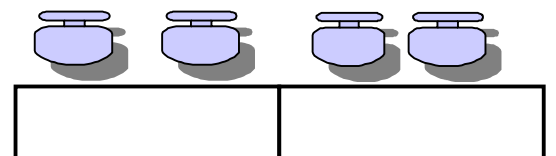
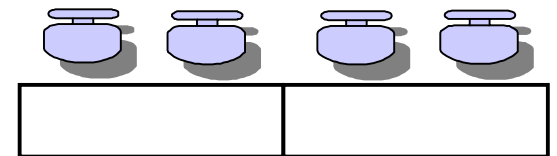
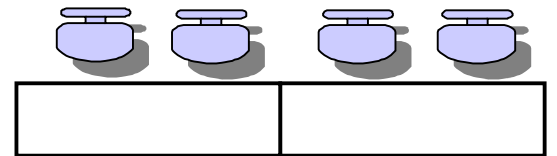
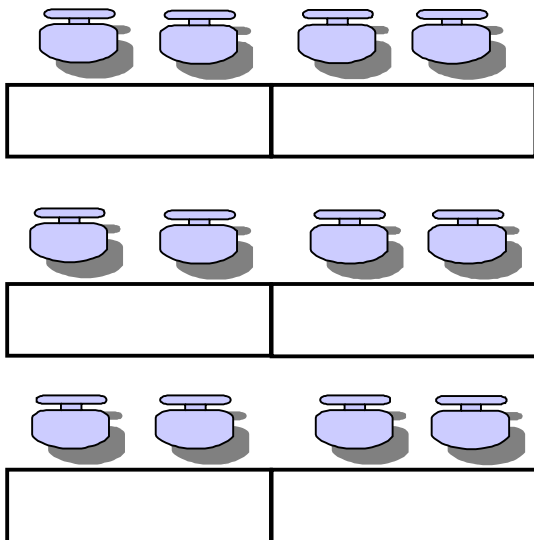

Salle 3C

3^{ème} étage

18 tables

36 places

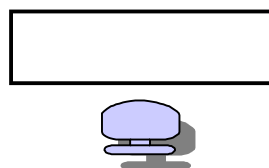
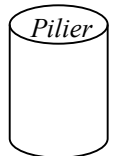
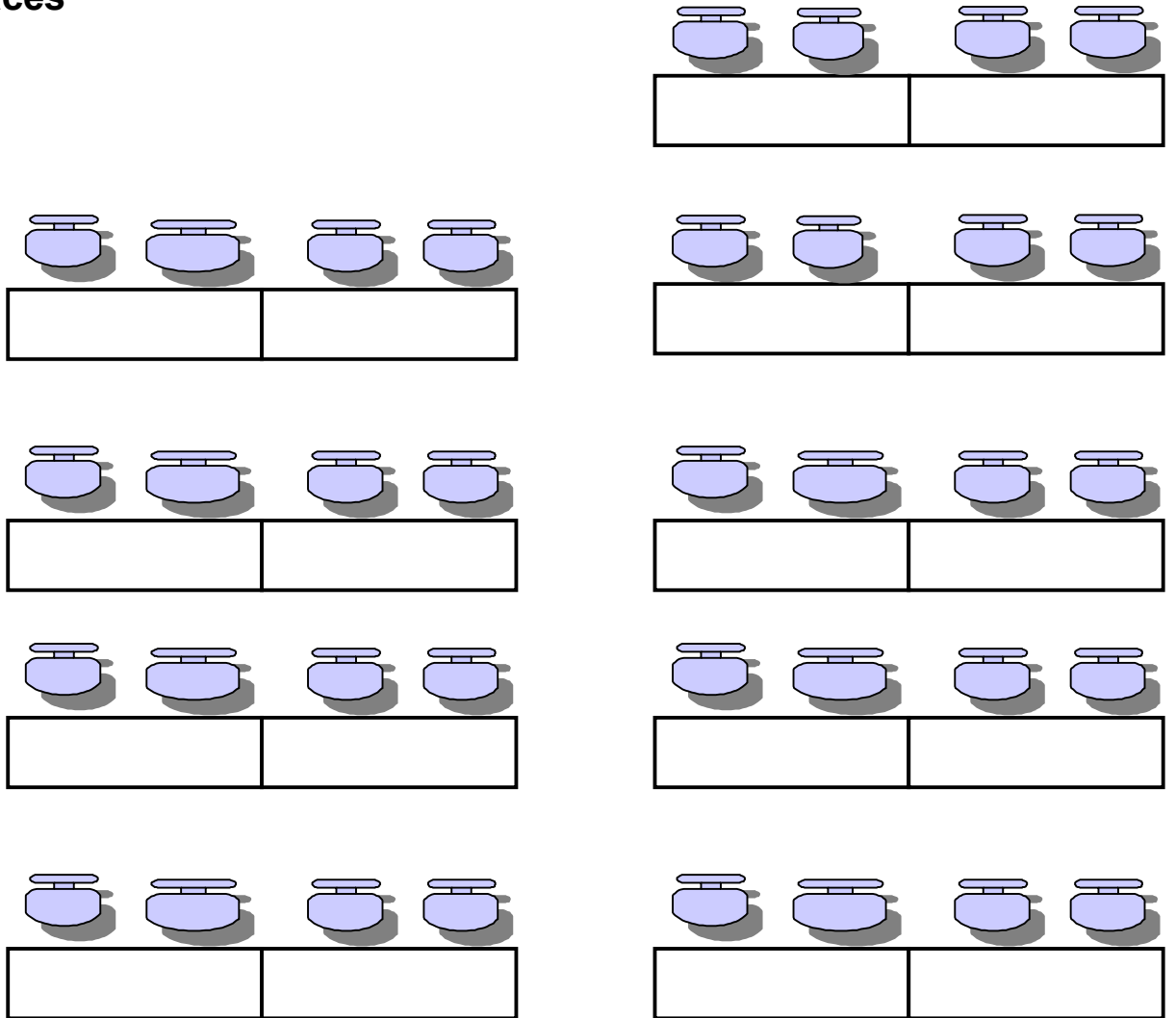

Salle 3D

3^{ème} étage

9 tables

18 places

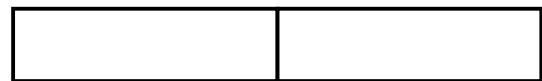
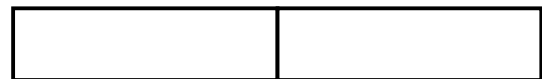
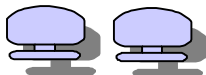
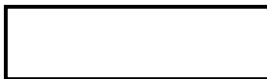
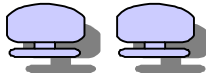
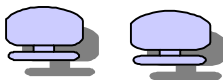
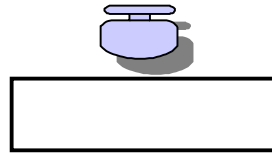

Salle des Conseils

Entresol

10 - 12 places

